

ERRATA.

Page 310, première indication marginale, sulfure d'antimoine, lisez : séléniure d'antimoine.

Page 310, deuxième indication marginale, séléniure de Tellere, lisez : séléniure de Tellure.

Page 349, troisième opération, troisième alinéa, au lieu de : on a coulé la geuse qui pesait 274^k, 1 de fonte pour 100^k de minerai, lisez : on a coulé la gueuse qui pesait 275^k, ce qui donne 44^k, 1 de fonte pour 100^k de minerai.

Page 450, ligne 18, au lieu de : et l'axe, lisez : et l'arc.

Page 455, ligne 13, à la phrase commençant par ces mots : *En effet Sméaton*, et finissant ainsi : *égale à celle du courant*, ligne 20, substituez la phrase suivante :

En effet, Sméaton obtient cette vitesse par le moyen d'un poids qu'il fait agir dans le même sens que le choc de l'eau, et qu'il augmente ou diminue successivement, jusqu'à ce que la circonférence de la roue prenne une vitesse égale à celle que ce poids lui communiquerait s'il agissait seul sur elle; époque à laquelle il n'y a plus de mouvement transmis de la part du fluide.

Imprimerie de Madame HUZARD (née VALLAT LA CHAPELLE).

BLEU.

Fig. 4.

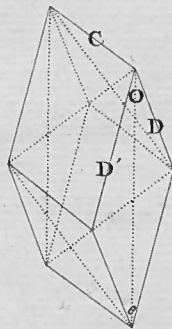
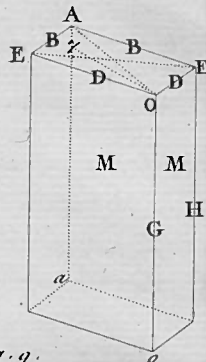

Fig. 5.



hexaèdre.

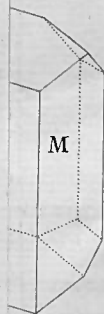

Fig. 9.

Subpyramide.

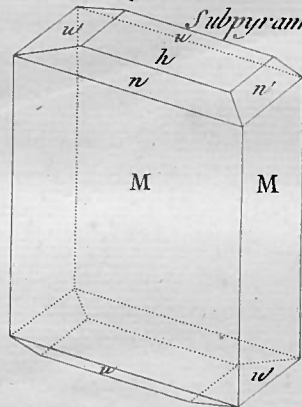
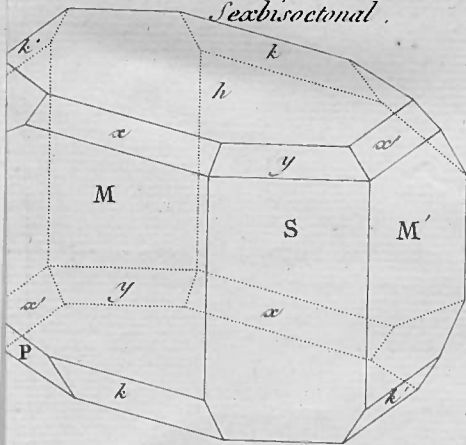

Fig. 12.

Sexbisoctonal.



CRISTAUX DE CUIVRE CARBONATE BLEU.

Fig. 1.

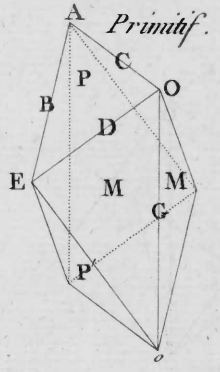

Fig. 2.

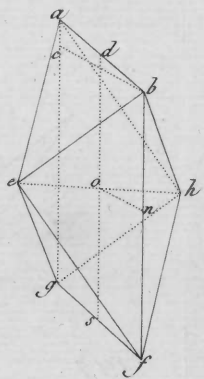

Fig. 3.

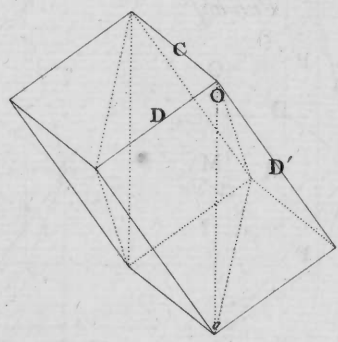

Fig. 4.

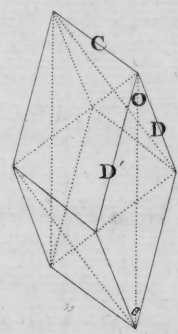

Fig. 5.

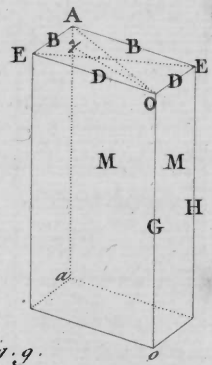

Fig. 6.

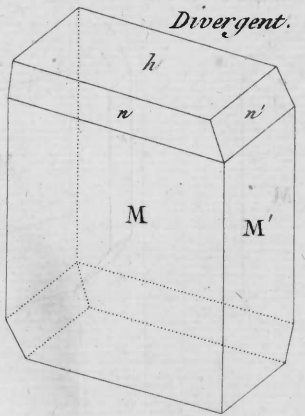

Fig. 7.

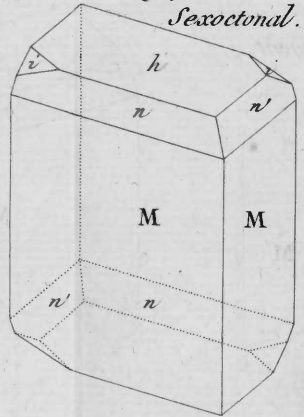

Fig. 8.

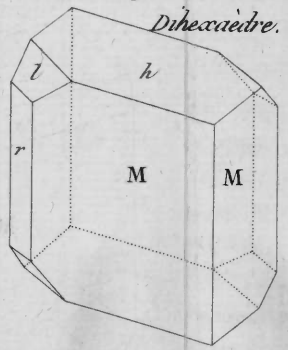

Fig. 9.

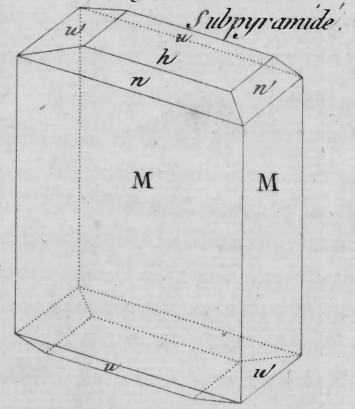

Fig. 10.

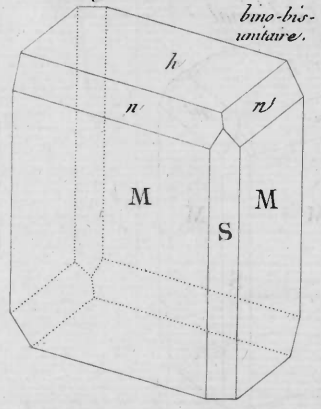

Fig. 11.

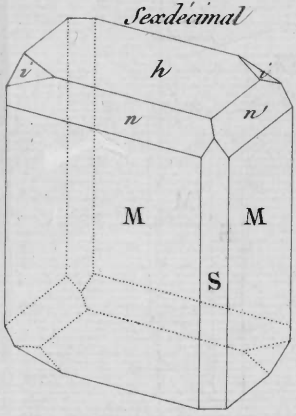
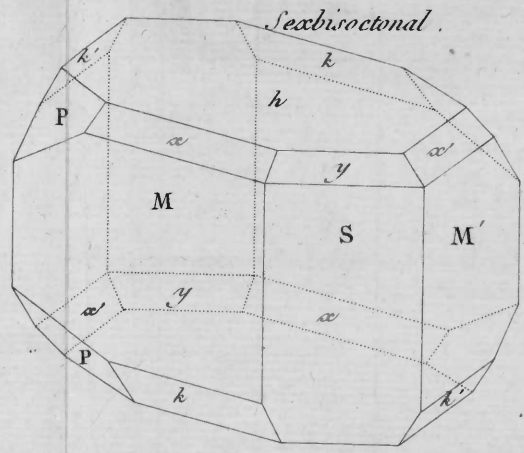
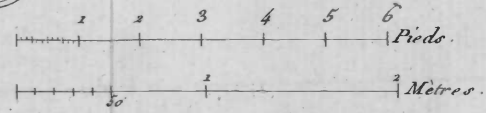
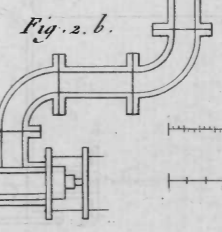
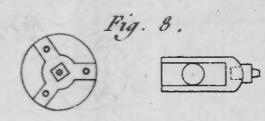
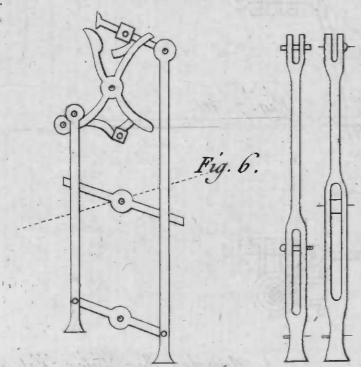
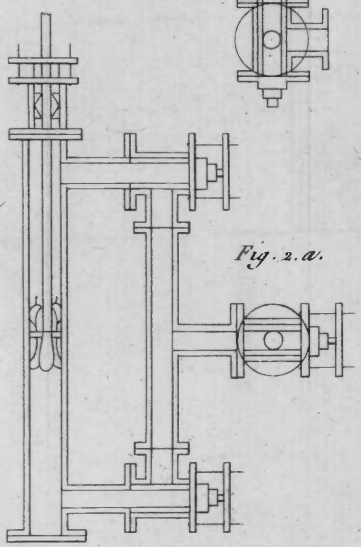
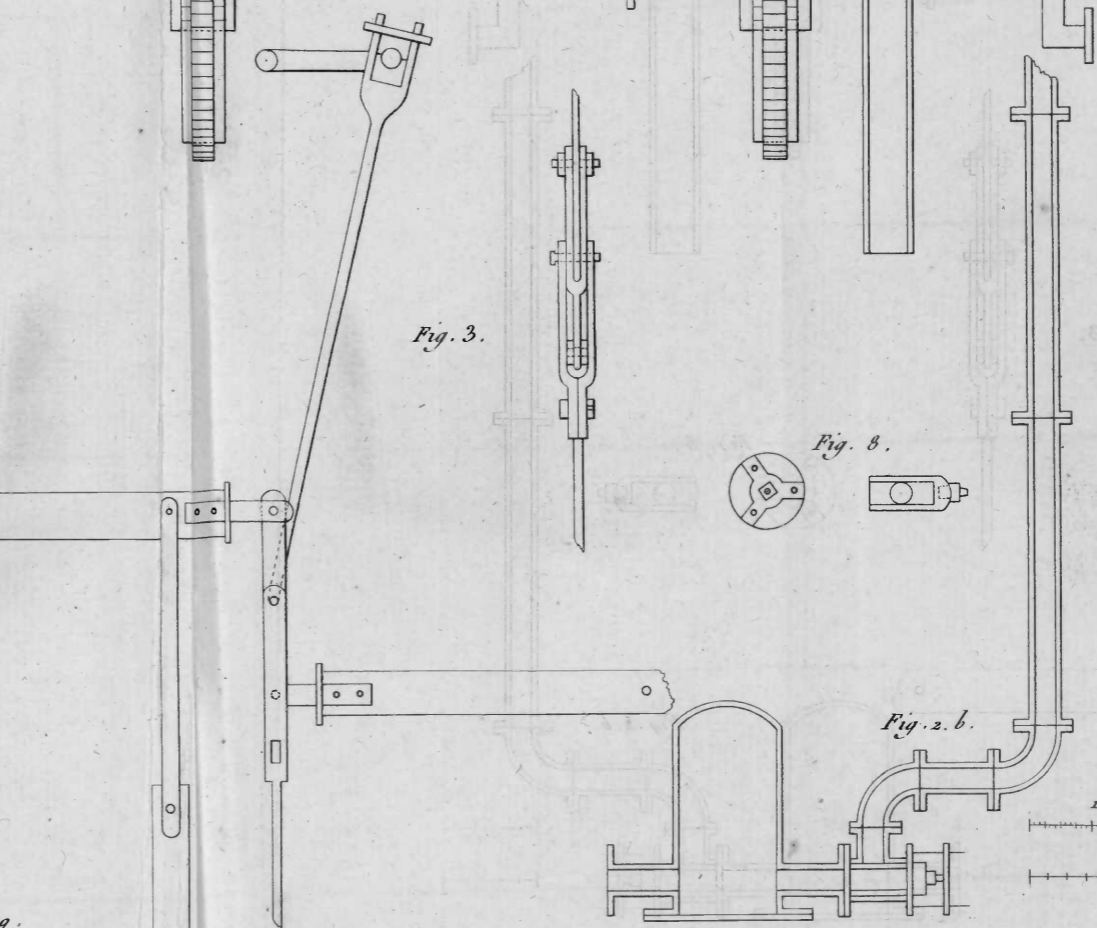
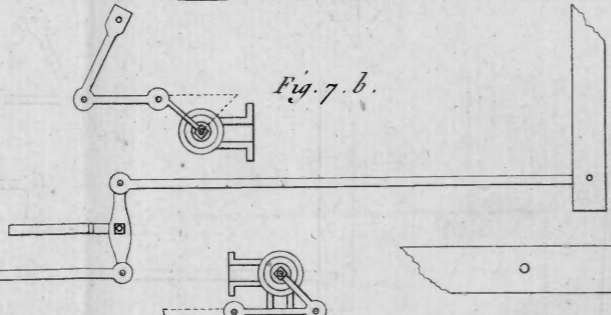
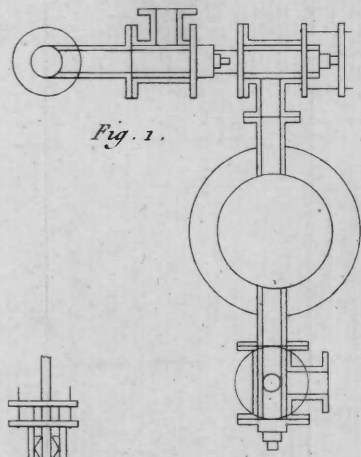
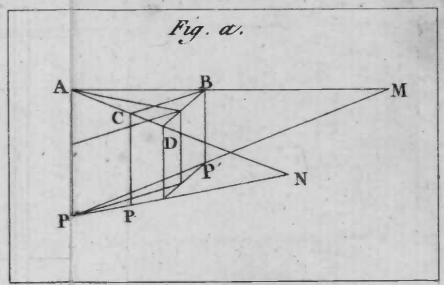
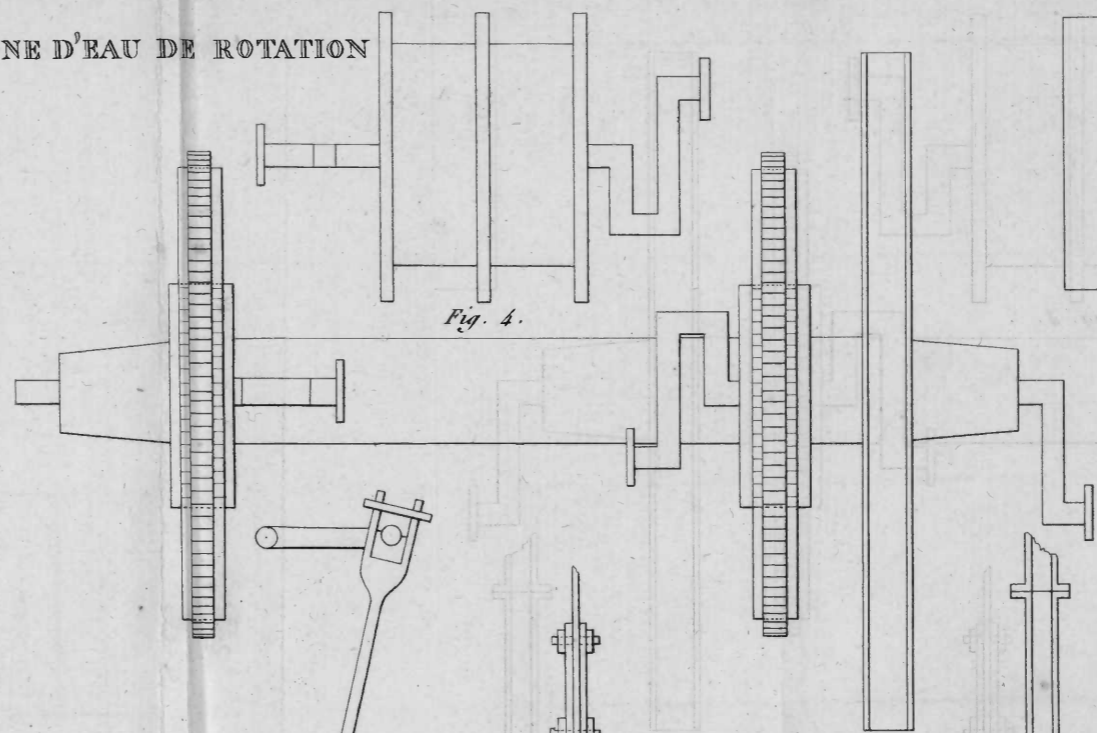
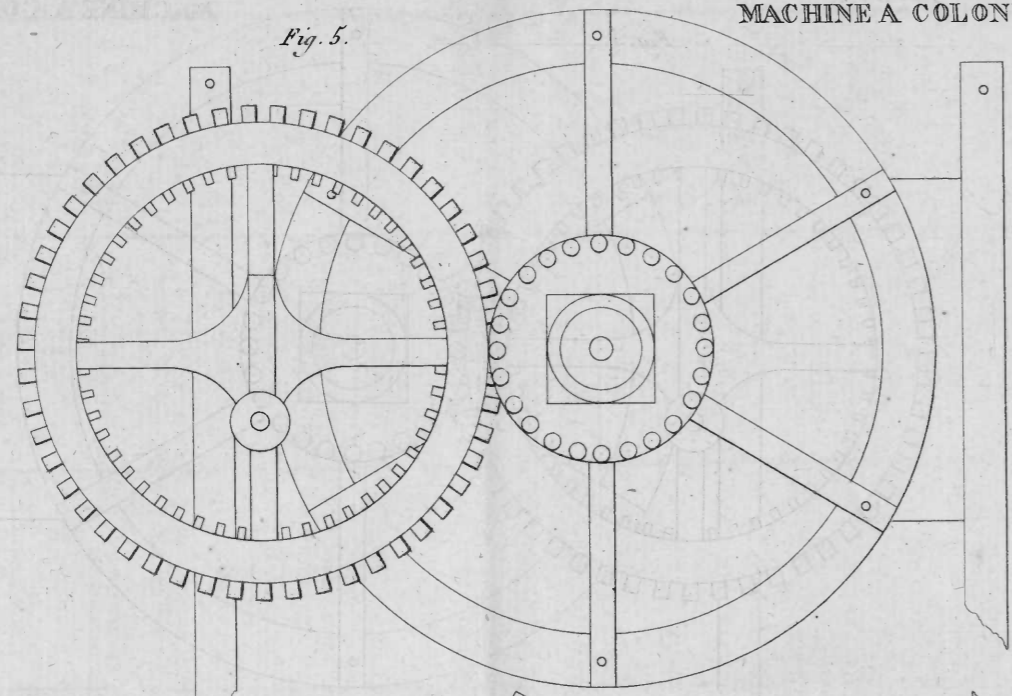

Fig. 12.



MACHINE À COLONNE D'EAU DE ROTATION



MODÈLE DE FOURNEAU POUR LA CARBONISATION DE LA TOURBE.

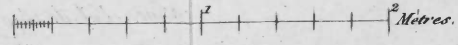
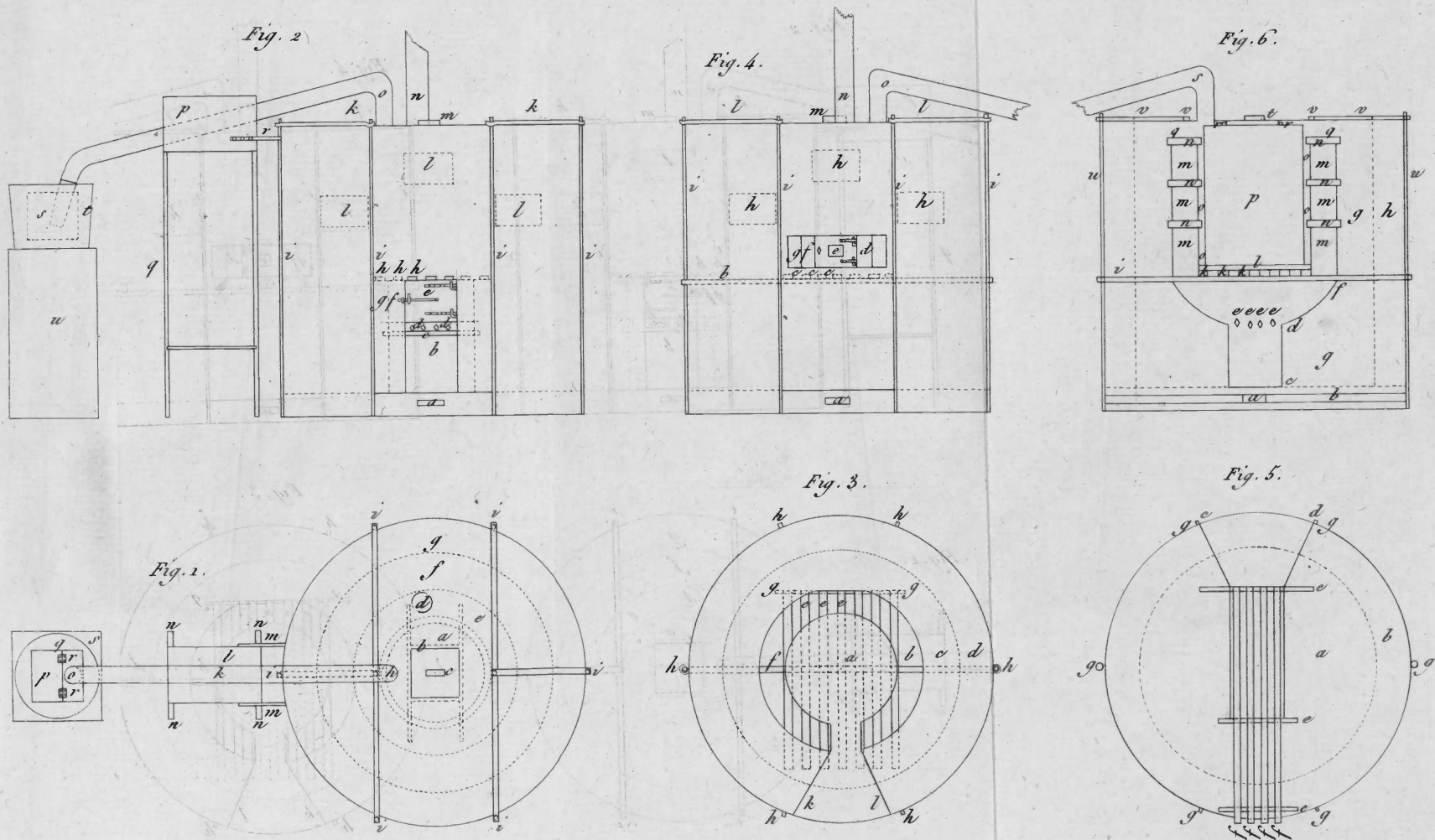

NOUVEAUX SOUFFLETS A VENT CONTINU.

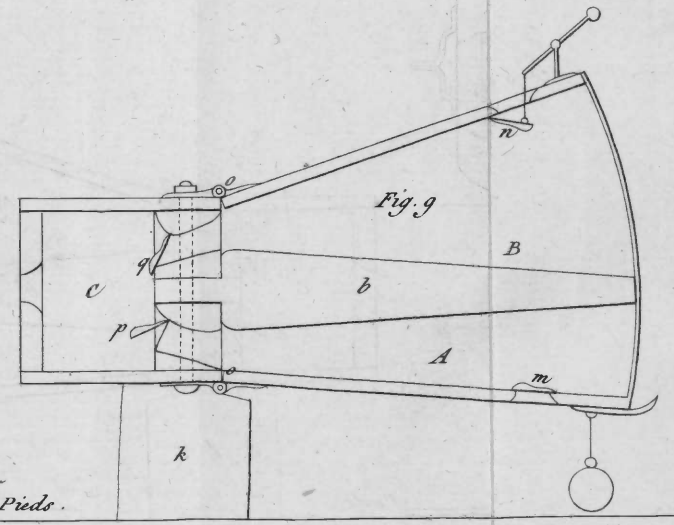
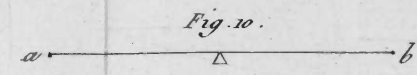
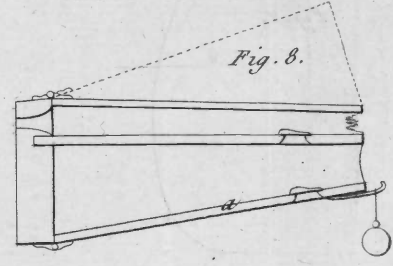
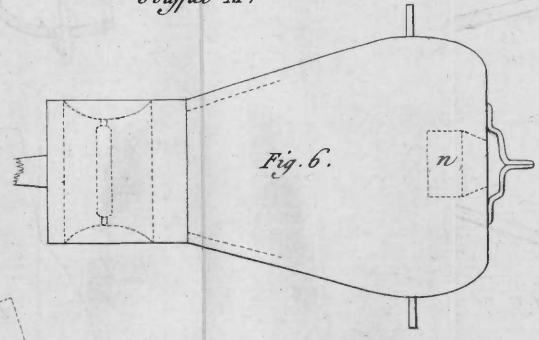
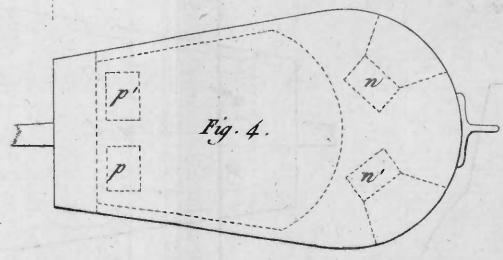
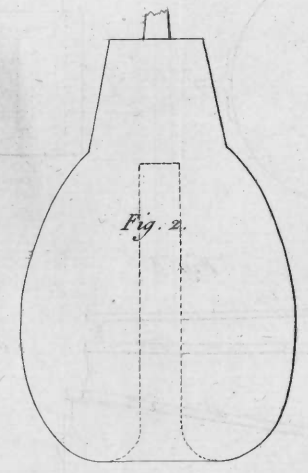
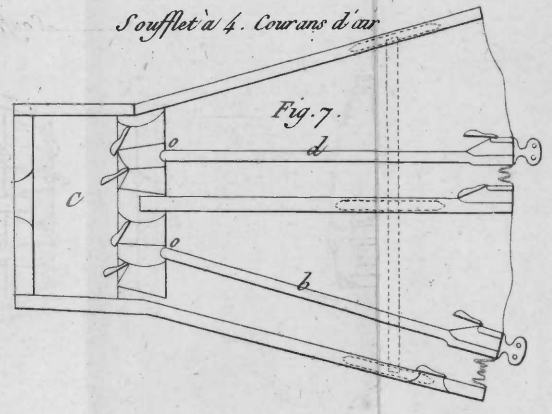
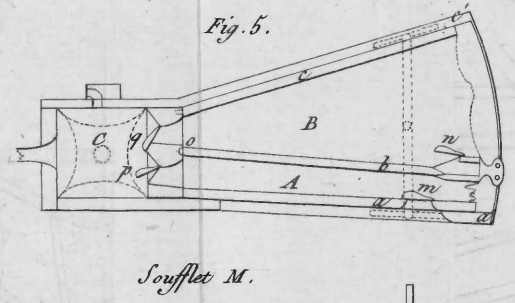
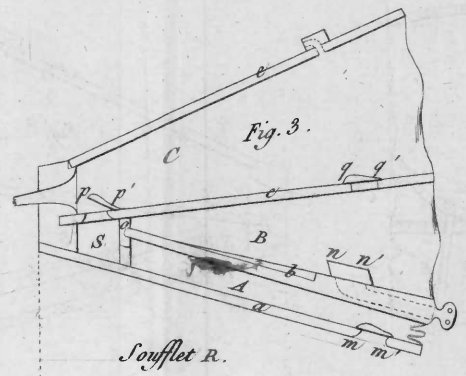
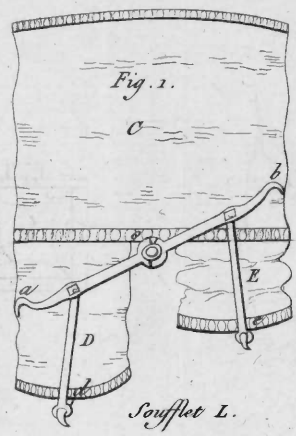

CARTE du Gisement du Gypse de BEX (Canton de Vaud.)

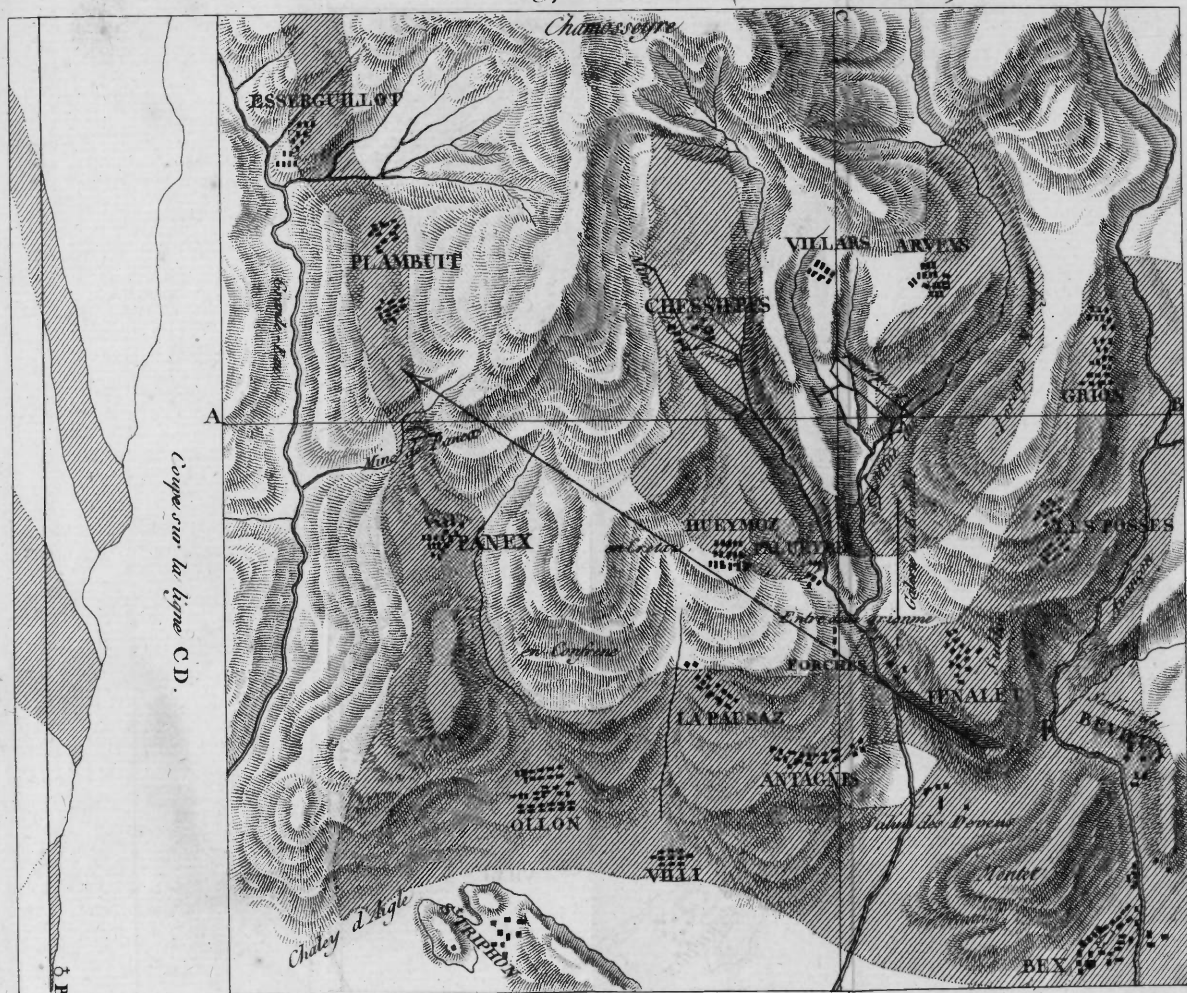

Coupe sur la ligne C D.

Coupe sur la ligne A B

Gypse
Calcaire

et autres roches de transition.

Toises de 10 pieds de Berne.

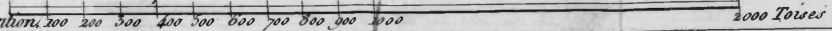

Annales des Mines, Vol. de 1839.

N.L. Rousseau Sculpt.

TRAITEMENT DU FER PAR LA HOUILLE.

